

Fiber Optic Sensor

**PFD RG** **INSTRUCTION MANUAL**

We appreciate you for purchasing HanYoung NUX Co., Ltd product. Before using the product you have purchased, check to make sure that it is exactly what you ordered. Then, please use it following the instructions below.

**HANYOUNG NUX**

**HEAD OFFICE** 1381-3, Juan-Dong, Nam-Gu Incheon, Korea  
TEL: (+82-32)876-4697 FAX: (+82-32)876-4696

**Safety Information**

Before you use, read safety precautions carefully, and use this product properly. The precautions described in this manual contains important contents related with safety; therefore, please follow the instructions accordingly. The precautions are composed of DANGER, WARNING and CAUTION.

**Warning**

- To prevent deflection or malfunction of this product, supply proper power voltage in accordance with the rating.
- Since this product is not designed with explosion-protective structure, do not use it at any place with flammable or explosive gas.
- Remove this product while the power is off. Otherwise, it may cause malfunction or electric shock.

**Caution**

- The contents of this manual may be changed without prior notification.
- If you use the product with methods other than specified by the manufacturer, there may be bodily injuries or property damages.
- Avoid continuously switching the power source On and Off.
- Use a dry cloth to wipe off the substance when cleaning the lens or cases. Never use thinner or organic solvents.
- Do not use this product at any place with much dust, vibration or impact.
- Before inserting power source, make sure that the circuit wiring is properly connected.
- In the case of wiring loaded inductors such as DC Relay and others to output, use diode, varistor and others to prevent surge.
- To avoid malfunction caused by noise, do not put high voltage or power line with sensor wire in a same conduit.
- Make its wiring be shorter as possible and wire extension shall be within 30 m.
- Do not apply a strong tension to the fiber optic cable.
- Do not curve the fiber optic cable over tolerable bending.
- Do not make any scratch on the cable.
- Consider the fact that the sensing distance may be varied in accordance with the size, color, surface condition, material, glossy, non-glossy or others of a sensing object.
- Prevent strong disturbance light such as sunlight and others which directly enter into the directional angle of the sensor by putting a glare shield.
- In the case of using multiple sensors (more than 2 sensors), there is a possibility of malfunction caused by mutual interference so, for Through-Beam type, sensors shall be installed in a divergent way or there shall be proper distance between them.
- When using the Switching Power Supply as the power source, earth the Frame Ground (F,G) terminal and be sure to connect the noise-eliminating condenser between 0 V and F,G.

**Suffix code**

Model	Code	Information
PFD	<input type="checkbox"/> <input type="checkbox"/> <input type="checkbox"/>	10 bit A/D, 4Digit display
Light source	R	Red LED
Use	G	General purpose(MARK)
	M	Multi type(MARK / RPM / COUNTER)
External output	N	NPN Open collector
	P	PNP Open collector

**Specification**

Type		Digit Display
Model	NPN	PFD-RGN
	PNP	PFD-RGP
Power supply voltage	12 - 24 V d.c ±10 % (Ripple less than 10 %)	
Current consumption	max 50 mA	
Output	Cont rol	NPN/PNP open collector output, max 100 mA (max. 30 V d.c)
	Stable	
External Input	Teaching	
Indicator range	0 ~ 1000	
Output	Light On / Dark On Output	
	NORMAL, ON DELAY, OFF DELAY, ONE Shot Time Output	
On/Off Delay	1 ~ 9999 ms	
OneShot Time	1 ~ 9999 ms	
Light source/Wavelength	Infrared lightening / 660 nm	
Protection Circuit	Built in the reversed power supply connection protective circuit and output short protective circuit	
Response time	max 0.7 ms	
Variation rate	max 10 %	
LED	7 contacts state indicating LED, 7 segments LED 4 digits	
Sensitivity adjustment	Auto teaching/Manual setting by using the set button	
Additional functions	Adjustable brightness, 180° rotation display	
	Display time setting, Lock function	
Ambient illumination	Sunlight : max 10,000 Lux, Incandescent lamp : max 3000 Lux	
Ambient temperature	-10 ~ 55 °C (Surrounding storage temperature : -25 ~ 70 °C)	
Ambient humidity	35 ~ 85 % RH. (With no condensation)	
Vibration resistance	10 - 55 Hz double amplitude 1.5 mg for 2 hours each in X, Y and Z directions	
Shock resistance	500 %, 3 times each in X, Y and Z directions	
Dielectric strength	1000 V a.c, 50/60 Hz for 1 min	
Insulation resistance	min 20 MΩ (500 V d.c between the code and case, between the adjustment switch and case)	
Connection method	Code extended type, Code length : 2 m, No. of lines : 5P, Thickness : Ø4mm, DIN rail installation structure	
Accessory	Bracket	

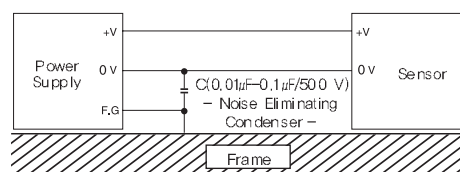

※ If you do not follow the contents described in the safety information then it is possible to be a cause of the product's malfunction so please follow them.

**Dimension**

Unit : mm

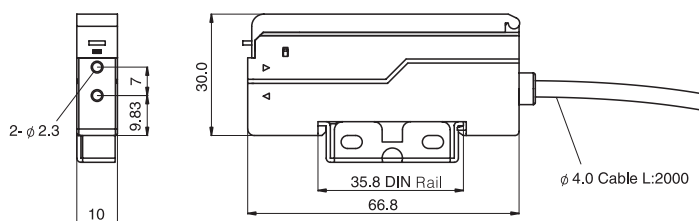

# Wiring circuit

## ■ NPN type

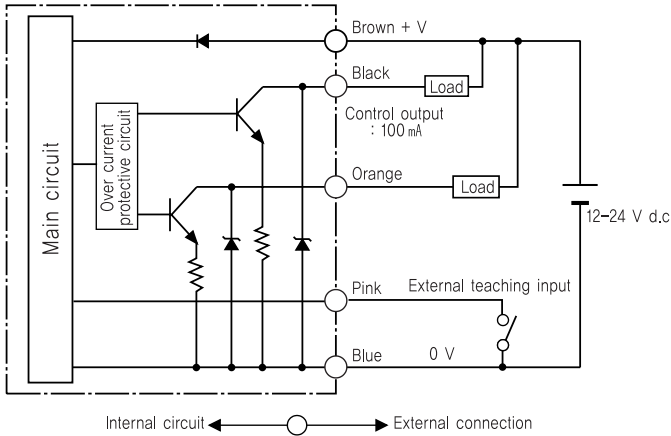

## ■ PNP type

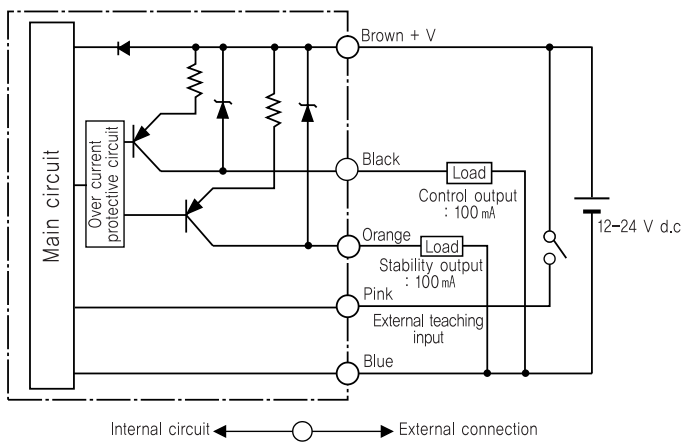

# Name of parts

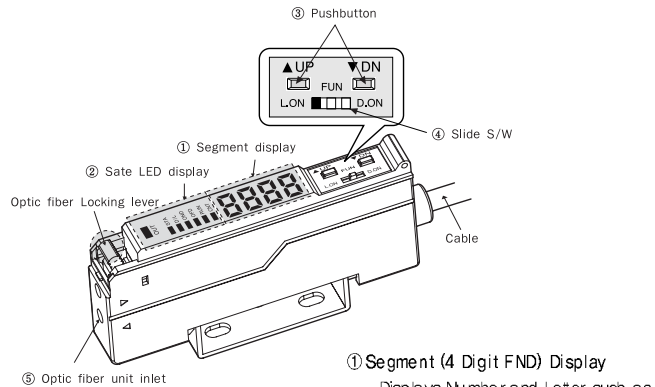

### ② LED Display (State)

Displays the state of Fiber Sensor

- OUT : Output status(OUT1)
- STB : Stable area indicator(OUT2)
- ON : Lights on when On Delay or One shot time are set at the Output
- OFD : Lights on when Off Delay is set at the Output

### ③ Push Button (▲UP, ▼DN)

Function change and value set up at each executive mode (L.ON, D.ON, FUN)

### ④ Slide S/W (L.ON, D.ON, FUN)

Sets up executive modes and priority operation at all functions

- L.ON / D.ON : General Fiber Sensor Operation Mode
- FUN : Various Additional Function Set Up Mode

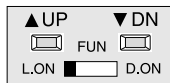

Parameter1 : Sensor Manual Sensitivity Set Up group

Parameter2 : Sensor Output Mode Set Up group

Parameter4 : Additional Function Set Up group

- L.ON : Light ON Mode
- D.ON : Dark ON Mode

※ Caution: Refer to the Parameter Chart for the Detailed Set Up and function of FUN

⑤ Fiber Optic Unit Input Hole External Diameter :  $\varnothing$ 2.2 mm Fiber unit

# Depending on receiving level, OUT and STB operation

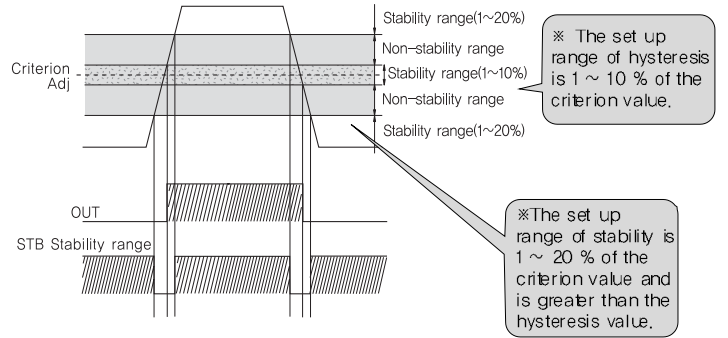

# Delay time setting and output operation

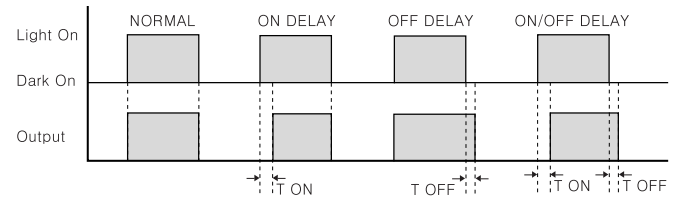

# Sensitivity adjustment

## ■ 2 Points teaching

It is teaching an object and background separately.

\* 2 points teaching is possible to control sensitivity adjustment regardless of object or background.

① Set the slide switch to D.ON or L.ON.

② ▲- Press UP button and indicates "t-1" (Place a fiber unit on an object)



③ ▲- Press UP button again (Place a fiber unit to background)

Indicates "t-2" and then "\_OK\_" (Finish setting and return to the operation mode)



## ■ 1 Point teaching

It is teaching a boundary between an object and background.

① Set the slide switch to D.ON or L.ON. (Place an object at the detecting area.)

② ▲- Press UP button and indicates "t-1" (Place a fiber unit to a boundary between an object and background.)



③ ▲- Press UP button again. (Finish setting and return to the operation mode) Indicates "t-2" and then "\_OK\_".



## ■ Auto teaching (For a moving object)

- ① Set the slide switch to D.ON or L.ON.  
(Pass the object through the detecting area.)
- ② **▼**- Press DN button and indicates "t-9" and then "\_OK\_"  
(Finish setting and return to the operation mode)



※ Note) When auto teaching is done at the Run mode, GAIN(1-1) and ADJ(1-2) will be automatically changed.

## ■ Parameter page list and initial default value

	Manual sensitivity setting (Basic input setting)		Sensor output setting (RUN MODE ONLY)		Subsidiary function setting	
	1 Group	Set value	2 Group	Set value	4 Group	Set value
1	GAIN	8	-	-	LOCK	DS
2	ADJUST	500	ON DELAY	OFF	BRIGHT	7
3	HYSTERESS	10	OFF DELAY	OFF	BRIGHT TIME	OFF
4	STABILITY	11	ONE SHOT	OFF	DISPLAY 180	0
5	-	-	TIME INPUT SW	AUTO	DEFAULT	-
6	-	-	CHANNEL	CH1	-	-

### ※ How to operate

Press the <b>▲</b> button instantly	Press the <b>▼</b> button instantly
Press the <b>▲</b> button firmly	Press the <b>▼</b> button firmly

## ■ 180° Rotation display

(Changed from FUN mode[4-4])

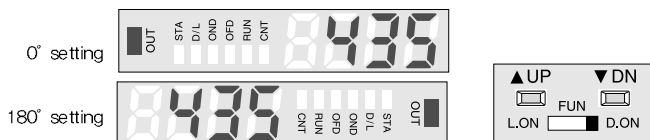

## Parameter

### ■ Parameter 1 group(Manual sensitivity Setup)

Move to Group 1 **▲** in FUN mode

Parameter menu and display	Explanation	Range	Setting KEY
1-1 GAIN	Set up 8 levels of amplifying rate for the amplifying circuit of the light receiver.	1(min) ~ 8(max)	<b>▼</b> : Setting value change <b>▲</b> : Setting done/return
1-2 ADJ	Set up the sensitivity (criterion value)	5 - 995	<b>▲</b> : Setting done/return
1-3 HST	Set up GAP of the criterion at the time of deciding the presence of sensing object.	1 ~ 10 %	
1-4 STB	Set up the Stability area at the time of deciding the presence of sensing object.	1 ~ 10 % HYSTERESS	

- 1) Move to the next parameter group by pressing **▲** when the parameter is displayed.
- 2) Current mode and current set up condition is displayed when moving the parameter.
- 3) Set up can be changed by firmly pressing on to **▼** for long time.
- 4) Just move the Slide S/W to L.ON or D.ON to move to the executive mode after completing the set up

### ■ Parameter 2 group(Sensor output Setup)

Move to Group 2 **▲** in FUN mode

Parameter menu and Display	Explanation	Range	Setting KEY
2-2 on d	Setup Out ON-Delay time	9999 ms	<b>▼</b> : Setting value change <b>▲</b> : Setting done/return
2-3 off d	Setup Out OFF-Delay time		
2-4 on ES	Setup ONE Shot output time		
2-5 E-IN	Setup outer IN-Port function(If input is over 1sec, it will run)	None 1-TE : 1 point teaching AUTO : Auto teaching	<b>▼</b> : Setting value change <b>▲</b> : Setting done/return
2-6 CHAN	Change frequency to prevent mutual interference of sensors	CH1 ch1 frequency CH2 ch2 frequency	<b>▼</b> : Setting value change <b>▲</b> : Setting done/return

- 1) Move to the next parameter group by pressing **▲** when the parameter is displayed.
- 2) Current mode and current set up condition is displayed when moving the parameter.
- 3) Set up can be changed by firmly pressing on to **▼** for long time.
- 4) Just move the Slide S/W to L.ON or D.ON to move to the executive mode after completing the set up.

※ Parameter 3group (Counter/RPM setting) function is only available with the model PFD-RM□

### ■ Parameter 4 group(Subsidiary function Setup)

Move to Group 4 **▲** in FUN mode

Parameter menu and Display	Explanation	Range	Setting KEY
4-1 LOCK	FUN mode lock (refer to 5)	En : Enable ds : Disable	<b>▼</b> : setting value change <b>▲</b> : setting done/return
4-2 brt	Brightness setting and FND brightness control	[1-7] stages	
4-3 br_t	Bright Time setting Bright keeping time	OFF, 5, 10, 15, 20, 30 sec 1, 2, 3, 4 min	
4-4 disp	Display rotation (180 rotation)	0 : normal 180 : 180 rotation	
4-5 init	Default setting (initial value setting)	Ent	















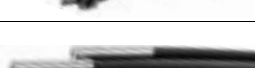
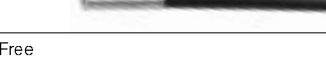

- 1) Move to the next parameter group by pressing **▲** when the parameter is displayed.
- 2) Current mode and current set up condition is displayed when moving the parameter.
- 3) Set up can be changed by firmly pressing on to **▼** for long time.
- 4) Just move the Slide S/W to L.ON or D.ON to move to the executive mode after completing the set up
- 5) LOCK Release Method : Press **▲** **▲** **▲** **▼** **▲** **▲** **▲** **▼** in order

# Fiber optic cable

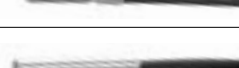
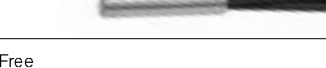
## ■ FIBER OPTIC CABLE

Internal diameter : I.

External diameter : E.

MODEL		APPEARANCE	SPECIFICATION	Ambient temperature	Length of cable
Through TYPE	Standard TYPE	GT-4310-2	Free 	-30 - 70 °C	2 m
	Standard TYPE (Round type)	GTR-2910-2	Free 		
	Standard TYPE	GT-4M10-2	Free 		
	Standard TYPE (Small)	GT-3005-2	Free 		
	Standard TYPE (Small Round type)	GTR-1505-2	Free 		
	SUS TUBE TYPE	GTS3-4005-2	Free 		
	Standard TYPE	GT-3075-2	Free 		
Reflection TYPE	Standard TYPE	GR-6210-2	Free 	-30 - 70 °C	2 m
	Standard TYPE	GR-6410-2	Free 		
	Standard TYPE	GR-4205-2	Free 		
	Standard TYPE (Small)	GR-3005-2	Free 		
	Standard TYPE (Round type)	GRR-3005-2	Free 		
	SUS TUBE TYPE	GRS3-4005-2	Free 		
	SUS TUBE TYPE	GRS2-6005-2	Free 		
	Co-axial TYPE	GR-62X5-2	Free 		
Surface detection TYPE	Liquid TYPE	GL-635-05	Free 	-40 - 80 °C	2 m
	Liquid TYPE	GL-635-1	Free 		1.5 m
Fiber Unit Protective Tube	GST - 310			-40 - 150 °C	1 m
	GST - 410				
	GST - 610				

Cautious) The sensing distance is being measured under the maximum durability by using the fiber amp of PFD series.

\* Cautious) This is the lists of fiber units currently on sale.