

## Star-Delta Timer with Free power, compact size W38×H42mm

### ■ Features

- Wide power supply range  
: 100-240VAC 50/60Hz /24-240VDC (universal)
- Wide time setting range and switching time
- T1(setting time): selectable 0.5 to 100 sec.
- T2(switching time): selectable 0.05, 0.1, 0.2, 0.3, 0.4, 0.5 sec.
- Close and DIN rail mounting  
with a dedicated socket (PS-M8) width 41mm
- Easy mounting and installation/maintenance  
with dedicated bracket for DIN 48×48mm
- Application: Starting large capacity motors



**⚠ Please read "Caution for your safety" in operation manual before using.**



### ■ Ordering information

<b>ATS</b>	<b>8</b>	<b>SD</b>	<b>-</b>	<b>4</b>	
				Power supply	4
				Time operation	SD
				Number of plug pins	8
				Item	ATS
					100-240VAC / 24-240VDC universal
					Star-Delta type
					8-pin plug type
					Small Analog Timer

※Sockets (PG-08, PS-08, PS-M8) are sold separately.

### ■ Specifications

Model		<b>ATS8SD-4</b>
Function		<b>Star-Delta Timer</b>
Control time setting range		0.5sec to 100sec (max. time)
Power supply		100-240VAC 50/60Hz /24-240VDC universal
Allowable voltage range		90 to 110% of rated voltage
Power consumption		100-240VAC : 3VA, 24-240VDC : 1.5W
Return time		Max. 100ms
Time operation		Power ON Start type
Control output	Contact type	λ contact: SPST(1a), Δ contact: SPST(1a)
	Contact capacity	250VAC 3A resistive load
Relay life cycle	Mechanical	Min. 10,000,000 operations
	Electrical	Min. 100,000 operations (250VAC 3A resistive load)
Repeat error		Max. ±0.2% ±10ms
λ setting error		Max. ±5% ±50ms
Voltage error		Max. ±0.5%
Temperature error		Max. ±2%
λ -Δ switching time error		Max. ±25%
Insulation resistance		100MΩ (at 500VDC megger)
Dielectric strength		2000VAC 50/60Hz for 1 min.
Noise resistance		±2kV the square wave noise (pulse width 1μs) by noise simulator
Vibration	Mechanical	0.75mm amplitude at frequency of 10 to 55Hz(for 1 min.) in each of X, Y, Z directions for 1 hour
	Malfunction	0.5mm mplitude at frequency of 10 to 55Hz(for 1 min.) in each of X, Y, Z directions for 10 min.
Shock	Mechanical	300m/s <sup>2</sup> (approx. 30G) in each of X, Y, Z directions 3 times
	Malfunction	100m/s <sup>2</sup> (approx. 10G) in each of X, Y, Z directions 3 times
Environment	Ambient temperature	-10 to 55°C, storage: -25 to 65°C
	Ambient humidity	35 to 85%RH, storage: 35 to 85%RH
Approval		<b>CE c UL US</b>
Accessory		Bracket
Unit weight		Approx. 72g

※Environment resistance is rated at no freezing or condensation.

(A) Photo electric sensor

(B) Fiber optic sensor

(C) Door/Area sensor

(D) Proximity sensor

(E) Pressure sensor

(F) Rotary encoder

(G) Connector/Socket

(H) Temp. controller

(I) SSR/Power controller

(J) Counter

(K) Timer

(L) Panel meter

(M) Tacho/Speed/ Pulse meter

(N) Display unit

(O) Sensor controller

(P) Switching mode power supply

(Q) Stepper motor& Driver&Controller

(R) Graphic/ Logic panel

(S) Field network device

(T) Software

(U) Other

# ATS8SD-4

## ■ Connections

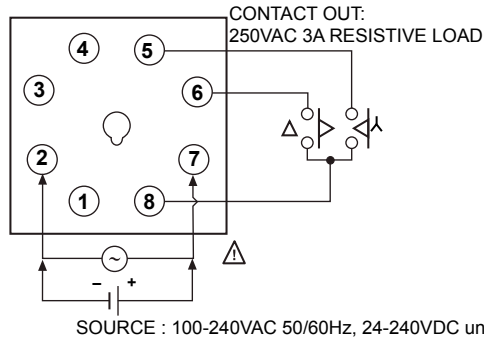

## ■ Dimensions

(unit: mm)

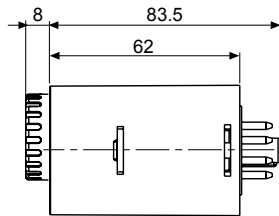
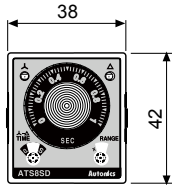

### ● Panel cut-out

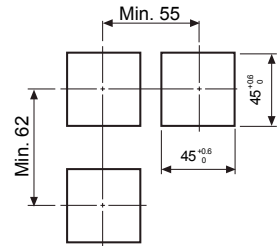

### ● Bracket

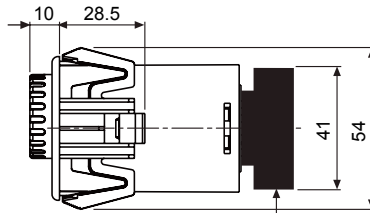
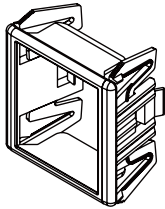

8-pin socket (sold separately)  
※Refer to G-15 page.

## ■ Parts description

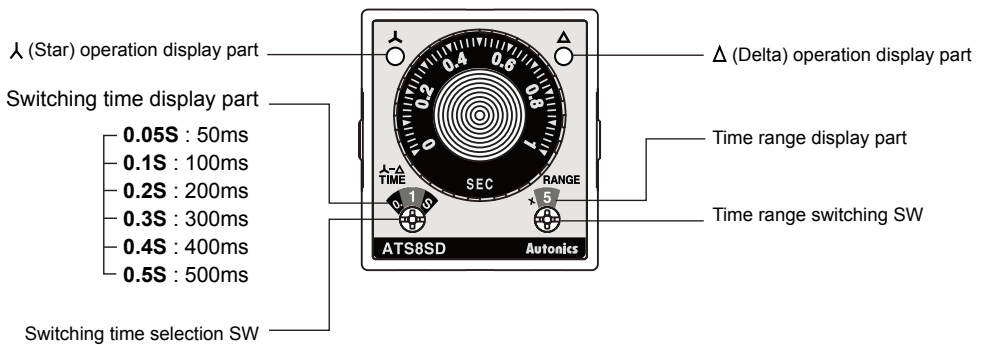

# Small Star-Delta Timer

## Time range

### 1. T1(setting time) time

Time range	Time unit	Setting time range
5	sec	0.5 to 5sec
10		1 to 10sec
50		5 to 50sec
100		10 to 100sec

### 2. T2( $\lambda$ - $\Delta$ switching time) time (unit: sec)

Switching time display part	0.05S	0.1S	0.2S	0.3S	0.4S	0.5S
T2 ( $\lambda$ - $\Delta$ switching time)	0.05	0.1	0.2	0.3	0.4	0.5

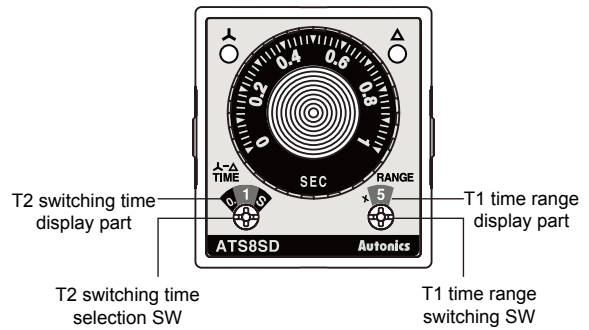

## Operation

When power is applied,  $\lambda$  contact will be ON. When reaching to T1 setting time,  $\lambda$  contact will be OFF and  $\Delta$  contact will be ON after switching time of T2 is passed. If the power is OFF,  $\lambda$  contact will be OFF.

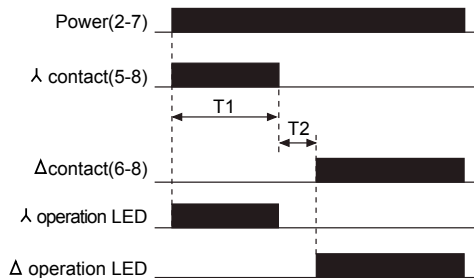

※T1: setting time ( $\lambda$  contact operation time)

※T2:  $\lambda$  - $\Delta$  switching time ( $\lambda$  contact and  $\Delta$  contact are OFF simultaneously at power ON)

## Proper usage

- Please supply power quickly at once with using switch or relay contact. Otherwise it may cause time error or power reset failure.
- When supplying power for a long time, timer life cycle may be shorten due to overheat of inner components of timer.
- When supplied power of timer is DC, be sure that the polarity.
- When supplying the power to the timer, connection shown in (Fig. 1) might cause malfunction due to leakage current through R and C. Please connect R and C as shown in (Fig. 2) to prevent malfunction.

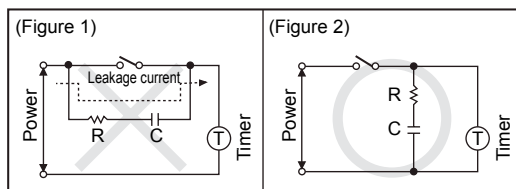

- Change the setting time (T1), time range or switching time(T2). Otherwise, it might cause malfunction if changing the setting time (T1), time range or switching time(T2) during operation.
- Do not use this unit at below places.
  - Place where temperature or humidity is out of the rated specifications.
  - Place where there is condensation by temperature changes.
  - Place where flammable gas or corrosive gas.
  - Place where there are dust, oil or severe vibration or impact.
  - Place where strong alkalis or acids are used.
  - Place where there are direct ray of the sun.
  - Place where strong magnetic field or electric noise are generated.

- (A) Photo electric sensor
- (B) Fiber optic sensor
- (C) Door/Area sensor
- (D) Proximity sensor
- (E) Pressure sensor
- (F) Rotary encoder
- (G) Connector/ Socket
- (H) Temp. controller
- (I) SSR/ Power controller
- (J) Counter
- (K) Timer
- (L) Panel meter
- (M) Tacho/ Speed/ Pulse meter
- (N) Display unit
- (O) Sensor controller
- (P) Switching mode power supply
- (Q) Stepper motor& Driver&Controller
- (R) Graphic/ Logic panel
- (S) Field network device
- (T) Software
- (U) Other