

LE8N Series

DIN W48×H24mm, Indication only, LCD timer(hour meter)

Upgrade

■ Features

- Upgraded features
Voltage input and backlight model, time specifications
- No additional power due to internal battery
- Signal input method: No-voltage input, voltage input, free voltage input
- Screw terminal type(attaching terminal cover)
- LCD display
- IP66 protection structure



⚠ Please read "Caution for your safety" in operation manual before using.



■ Ordering information

LE	8	N	-	B	N	-	L	
Digit		Size		Power supply	Input type		Backlight	Item
※Shaded (□) parts are upgraded or added function.								
		No mark	None					
		L	Backlight function					
		N	No-voltage(Small signal) input					
		V	Voltage input					
		F	Free voltage input					
		B	Internal lithium battery					
		N	DIN W48×H24mm					
		8	99999999(8 digit)					
		LE	LCD Timer					

■ Specifications

Model	LE8N-BN	LE8N-BN-L	LE8N-BV	LE8N-BV-L	LA8N-BF
Digit	8 digit(0 to 99999999)				
Digit size	W3.4 × H8.7mm				
Display method	LCD Zero Blanking type(character height size: 8.7mm)				
Operation method	Count up				
Power supply	Built-in battery				
Battery life cycle	Approx. over 10 years at 20°C				
Backlight power supply	—	24VDC±10%	—	24VDC±10%	—
Input method	No-voltage input		Voltage input		Free voltage input
Count input(Counter)	Residual voltage: Max. 0.5VDC Short-circuit impedance: Max. 10kΩ Open-circuit impedance: Min. 750kΩ		"H" level voltage: 4.5-30VDC "L" level voltage: 0-2VDC		"H" level voltage: 24-240VAC/6-240VDC "L" level voltage: 0-2VAC/0-2.4VDC
RESET input	No-voltage input		Voltage input		No-voltage input
Min. signal width	SIGNAL INPUT, RESET input: Min. 20ms				
Time specification(TS1)	99995959(h.m.s), 99999599(h.m), 99999959(h.m)				
Time specification(TS2)	99992359(d.h.m), 9999d239(d.h), 99999999(s)				
Time specification(TS3)	9999h599(h.m), 99999h59(h.m), 9999999h(h)				
Time error	±0.01%(time error, temperature error)				
External set switch	SW1 ^{※1} , SW2 ^{※2} , SW3 ^{※3}				
Insulation resistance	Min. 100MΩ(at 500VDC megger)				
Dielectric strength ^{※4}	2,000VAC 60Hz for 1minute				
Vibration	Mechanical	0.75mm amplitude at frequency of 10 to 55Hz(for 1 min.) in each of X, Y, Z directions for 1 hour			
	Malfunction	0.3mm amplitude at frequency of 10 to 55Hz(for 1 min.) in each of X, Y, Z directions for 10 minutes			
Shock	Mechanical	300m/s ² (approx. 30G) in each of X, Y, Z directions for 3 times			
	Malfunction	100m/s ² (approx. 10G) in each of X, Y, Z directions for 3 times			
Environment	Ambient temperature	-10 to 55°C, storage: -25 to 65°C			
	Ambient humidity	35 to 85%RH, storage: 35 to 85%RH			
Protection	IP66(using waterproof rubber for front panel)				
Accessory	Mounting bracket, Rubber waterproof ring				
Approval	CE, C, UL				
Weight ^{※5}	Approx. 96g(approx. 50g)				

※1: SW1 is the front panel RESET key enable/disable set switch. ※2: SW2 is the time range set switch.

※3: SW3 is available to select time specification TS1, TS2, or TS3.

※4: No-voltage input, voltage input: between terminals and the case / Free voltage input: between the free voltage input terminal and the RESET input terminal, between terminals and the case

※5: This weight is with packaging and the weight in parentheses is only unit weight.

※Environment resistance is rated at no freezing or condensation.

■ Connections

Input type	No-backlight	Backlight function
No-voltage input type	<p>●LE8N-BN^{※1}</p>	<p>●LE8N-BN-L^{※2}</p>
Voltage input type	<p>●LE8N-BV^{※1}</p>	<p>●LE8N-BV-L^{※2}</p> <p>※Backlight power is available as signal input (SIGNAL INPUT, RESET).</p>
Free voltage input type	<p>●LE8N-BF</p> <p>※Terminal (1, 2) and (4, 5) are insulated inside.</p>	

※1: Terminal 2 and 5 are connected inside. (Non-isolated)

※Use reliable contacts enough to flow 5μA current.

※2: Terminal (1, 2, 3) and (4, 5) are insulated inside.

■ Dimensions

● Bracket

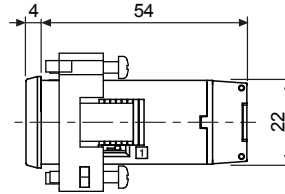
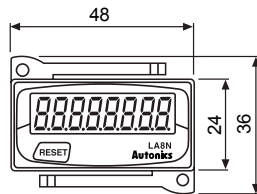
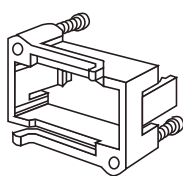

● Panel cut-out

(unit: mm)

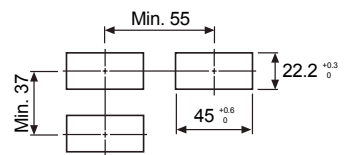

■ Time operation

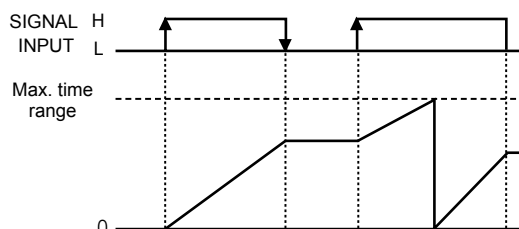

(A) Photo electric sensor

(B) Fiber optic sensor

(C) Door/Area sensor

(D) Proximity sensor

(E) Pressure sensor

(F) Rotary encoder

(G) Connector/Socket

(H) Temp. controller

(I) SSR/Power controller

(J) Counter

(K) Timer

(L) Panel meter

(M) Tacho/Speed/Pulse meter

(N) Display unit

(O) Sensor controller

(P) Switching mode power supply

(Q) Stepper motor& Driver&Controller

(R) Graphic/Logic panel

(S) Field network device

(T) Software

(U) Other

LE8N Series

Input connections

No-voltage input (standard sensor: NPN open collector output type)

Solid-state input

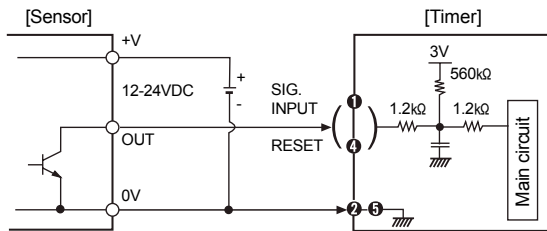

※When power is applied to terminal No ① and ④, input terminal circuit can be broken and a malfunction can occur. (NPN output, PNP output, PNP open collector output type sensor cannot be used.)

※② and ⑤ are connected inside.

※For backlight function model, the input terminals are no. ①, ③ and the GND terminal is no. ②.

Contact input

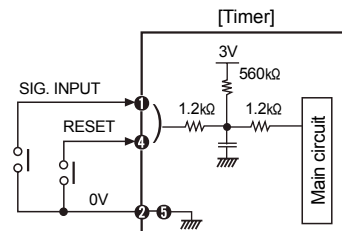

※Please use reliable contacts enough to flow 3VDC 5μA of current.

Voltage input (standard sensor: PNP open collector output type)

Solid-state input

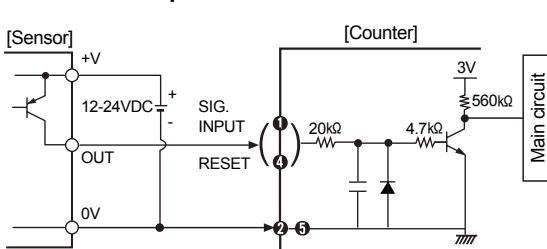

※For backlight function model, the input terminals are no. ①, ③ and the GND terminal is no. ②.

Contact input

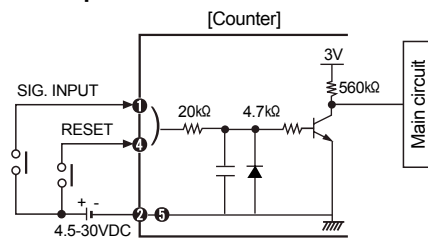

※Please use reliable contacts enough to flow 3VDC 5μA of current.

Free voltage input

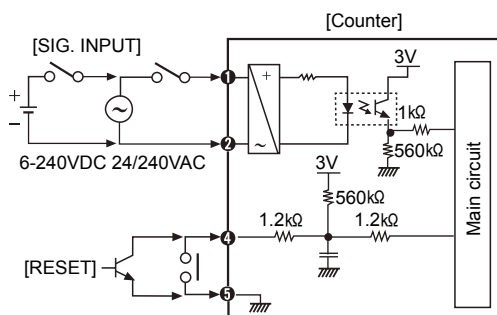

※AC type proximity sensor cannot be used as the source of count input signals.

※Input terminal (①, ②) and reset terminal (④, ⑤) are insulated inside.

※It is not possible to reset with AC power or DC power.

※When relay contact is used as the source of RESET signal, please use reliable contacts enough to flow 3VDC 5μA of current.

Input from AC type proximity sensor

In case of free voltage input type, do not connect AC proximity sensors instead of a switch as shown in the figure 1. It may cause malfunction due to sensor's leakage current. Connect a relay as shown in the figure 2.

(Fig. 1)

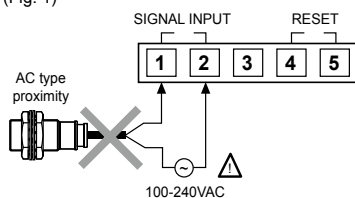

<Example of wrong connection>

(Fig. 2)

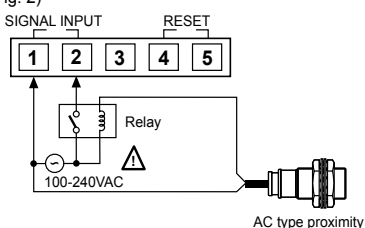

<Example of correct connection>

■ Set switch

⊙ SW1(1 switch)

SW1 is a switch to Enable/Disable the front panel RESET key.
 ※Factory default: Enable

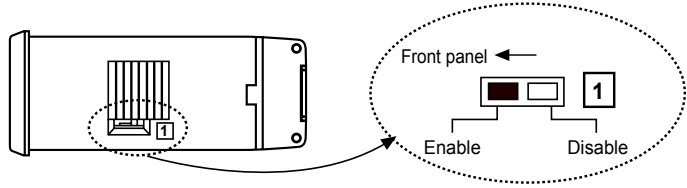

⊙ SW2(2 switch)

SW2 is a switch for setting time range.
 ※Factory default: 999959.59(h.m.s)

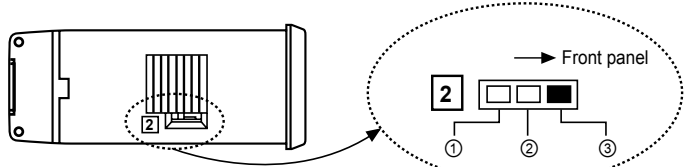

※Refer to "<Time range>" table of SW3 for ①, ②, ③ descriptions.

⊙ SW3 setting

SW3 is a switch for setting time specification. TS1, TS2, TS3(※Factory default: TS1)

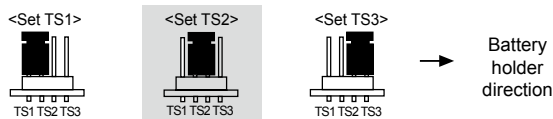
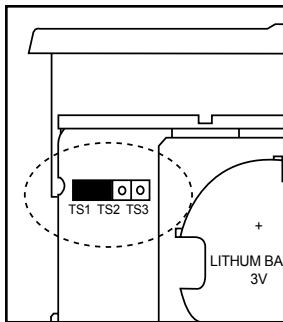

<Time range>*1

	TS1	TS2	TS3
①	hour min. 999999.59	sec. 99999999	hour 999999.9h
②	hour min. 999999.599	day hour 9999d23.9	hour min. 999999h.59
③	hour min. sec. 999999.599	day hour min. 9999d23.59	hour min. 9999h.599

※1: Time range is set as SW2, SW3 combination.

■ Case detachment and battery replacement

● Case detachment

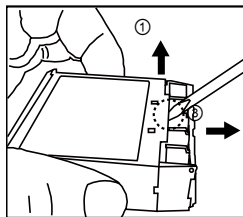
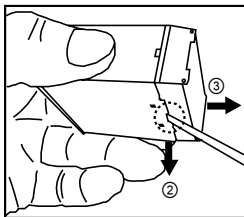

※Hold up Lock part toward ①, ② of the product with the tool and pull toward ③ to detach the case.

⚠When using the tools, be careful not to be wounded.

● Battery replacement

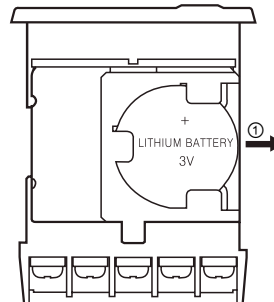

1. Detach the case.
 2. Push the battery and detach it toward ①.
 3. Insert a new battery with correct alignment of polarity pushing it toward opposite of ①.
- ※The battery is sold separately. Please replace a battery by yourself.
 ※Do not burn up or disassemble the lithium battery.

(A)	Photo electric sensor
(B)	Fiber optic sensor
(C)	Door/Area sensor
(D)	Proximity sensor
(E)	Pressure sensor
(F)	Rotary encoder
(G)	Connector/Socket
(H)	Temp. controller
(I)	SSR/ Power controller
(J)	Counter
(K)	Timer
(L)	Panel meter
(M)	Tacho/ Speed/ Pulse meter
(N)	Display unit
(O)	Sensor controller
(P)	Switching mode power supply
(Q)	Stepper motor& Driver&Controller
(R)	Graphic/ Logic panel
(S)	Field network device
(T)	Software
(U)	Other