

PMC-4B-PCI

4-Axis board type programmable motion controller

■ Features

- Available to control 4-Axis independent AC servo motor and stepper motor
- PC-PCI card
- Auto home search and synchronous operation
- Interpolation on circular/linear, bit pattern/continuous/ ac/ deceleration drive
- 2/3-Axis constant linear velocity.
- Compatible with windows 98, NT, 2000, XP, 7
- Supports Labview library and help, C language library and examples (download them at Autonics website)

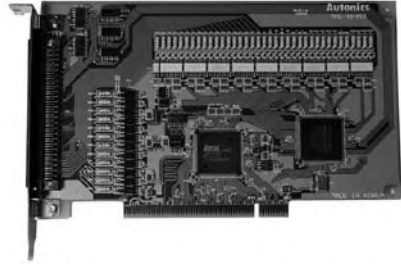

※ Visit our website (www.autonics.com) to download the user manual.

⚠ Please read "Caution for your safety" in operation manual before using.



■ Ordering information

PMC - 4B - PCI

Item	Axis/Type	Connection type	PCI	PCI
			4B	4-Axis board type
			PMC	Programmable motion controller

■ Specifications

Model	PMC-4B-PCI	
Control axis	4-Axis	
Power supply	5VDC(uses PC inner power)	
External power supply	12-24VDC	
Allowable voltage range	90 to 110% of rated voltage	
CPU data bus	8/16 Bit selectable	
2/3-Axis linear interpolation	Interpolation range	-2,147,483,648 to 2,147,483,647 for each axis
	Interpolation speed	1pps to 4 Mpps
	Shortcut position accuracy	Max. ±0.5LSB(Within all interpolation range)
Circular interpolation	Interpolation range	Uses PC inner power
	Interpolation speed	1pps to 4 Mpps
	Shortcut position accuracy	Max. ±1 LSB(Within all interpolation range)
2/3-Axis bit pattern interpolation speed	1 to 4MPPS(Depends on CPU data setup)	
Other interpolations	Selectable the axis, constant linear velocity, consecutive interpolation, interpolation step transmission(Command, external signal)	
X, Y-axis common specifications	Output speed range	: 1 pps to 4 Mpps
	Output speed accuracy	: Max ±0.1%(For setting value)
	Speed magnification	: 1 to 500
	S jerk speed	: 954 to 62.5×10^6 pps/sec. (Mag.=1)
	(Accel/Decel increase rate)	: 477×10^3 to 31.25×10^6 pps/sec. (Mag.=500)
	Accel/Decel	: 125 to 1×10^6 pps/sec. (Mag.=1)
		: 62.5×10^3 to 500×10^6 pps/sec. (Mag.=500)
	Initial velocity	: 1 to 8,000pps(Mag.=1)/500 to 4×10^6 pps(Mag.=500)
	Drive speed	: 1 to 8,000pps(Mag.=1) / 500 to 4×10^6 pps(Mag.=500)
	Number of output pulses	: 0 to 4,294,967,295(Fixed pulse drive)
Encoder input pulse	Inputtable 2-phase pulse/Up-Down pulse, Selectable 2-phase pulse 1, 2, 4 multiply	

4-Axis Motion Controller

■ Specifications

Position counter	Logic position counter(For output pulse) count range: -2,147,483,648 to +2,147,483,647 Actual position counter(For input pulse) count range: -2,147,483,648 to 2,147,483,647	
Compare register	Comp.+ register position compare range: -2,147,483,648 to +2,147,483,647	
	Comp.- register position compare range: -2,147,483,648 to +2,147,483,647	
	Status output for position counter size, signal output Enables to operate as software limit	
Auto home search	Step 1(High speed near home search) → Step2(Low speed near home search)	
Interrupt function (Except interpolation)	1drive pulse output When changes position counter ≥ COMP-, When changes position counter ≤ COMP+ When changes position counter < COMP-, When changes position counter < COMP+ When starting constant speed in accel/decel drive, when ending constant speed in accel/decel drive when ending drive, when ending auto home search, Synchronous operation	
Drive adjustment by external signal	Enable to fixed/continuous pulse drive of +/- direction by EXP+/EXP- signal	
	Enable to drive 2-phase encoder signal mode(Encoder input)	
External deceleration stop/ immediate stop signal	IN 0 to 3 each axis 4-point	
	Selectable signal valid/invalid and logical level, usable as general input	
Input signal for servo motor	Selectable alarm, INPOS signal valid/invalid and logic level	
General output signal	OUT4 to 7 each axis 4-point(Uses same terminal with drive status output signal)	
Drive status signal output	ASND (Accelerating), DSND(Decelerating)	
Overrun limit signal input	Selectable + direction, - direction each 1-point and logic level	
	At active, selectable immediate stop/decelerate stop	
Emergency stop signal input	EMG 1-point, stops drive pulse of all axes by low level	
Integral filter	Built-in integral filter at each input signal input terminal, selectable pass time(8 types)	
Others	Selectable the axis, constant linear velocity, consecutive interpolation, interpolation step transmission(Command, external signal)	
Environment	Ambient temperature	0 to 45°C, storage: -10 to 55°C
	Ambient humidity	35 to 85%RH, storage: 35 to 85%RH
Approval	CE	
Unit weight	Approx. 98g	

※Environment resistance is rated at no freezing of condensation.

■ System

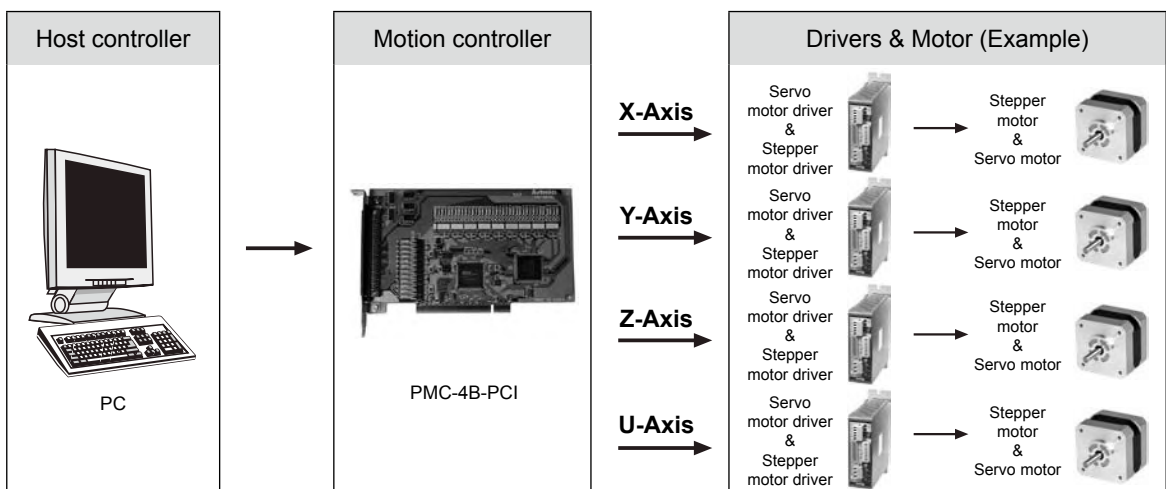

- (A) Photo electric sensor
- (B) Fiber optic sensor
- (C) Door/Area sensor
- (D) Proximity sensor
- (E) Pressure sensor
- (F) Rotary encoder
- (G) Connector/Socket
- (H) Temp. controller
- (I) SSR/Power controller
- (J) Counter
- (K) Timer
- (L) Panel meter
- (M) Tacho/Speed/ Pulse meter
- (N) Display unit
- (O) Sensor controller
- (P) Switching mode power supply
- (Q) Stepper motor & Driver&Controller
- (R) Graphic/Logic panel
- (S) Field network device
- (T) Software
- (U) Other

PMC-4B-PCI

■ Dimensions

(unit: mm)

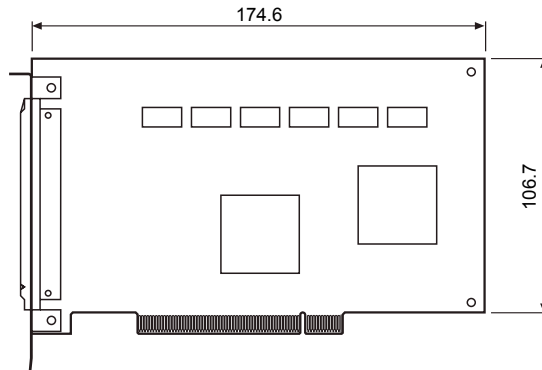

■ Connections

◎ Connection of pulse output signal for operating driver (nP+P/N, nP-P/N)

PMC-4B-PCI outputs pulse for operating driver as +/- of CW/CCW output using Line driver (AM26c31) and refer to the follows connections of motor driver with photocoupler and line driver input.

● Connection to motor driver with photocoupler

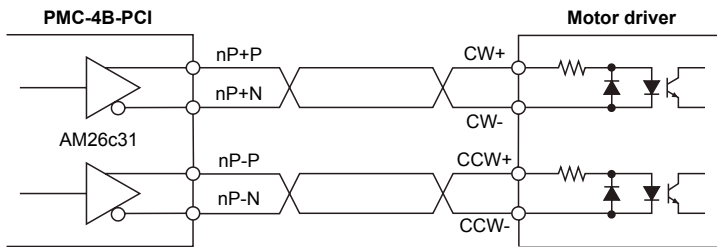

● Connection to motor driver with line driver

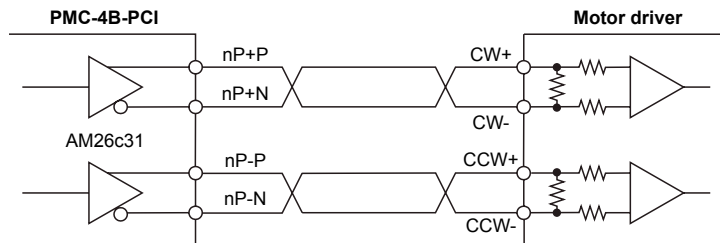

※It is recommended to use twisted pair shield wire for pulse output signal of driver operation regarding EMC.

◎ Connection of common output signal (nOUT4 to 7)

Output signal is outputted by buffer(74LS06), and all outputs are OFF after reset.

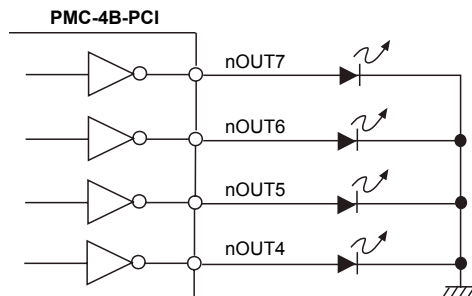

4-Axis Motion Controller

◎ Connection of encoder input signal(nECAP/N, nECBP/N) and nINO+/- signal

- Connection of encoder input signal and auto output line driver

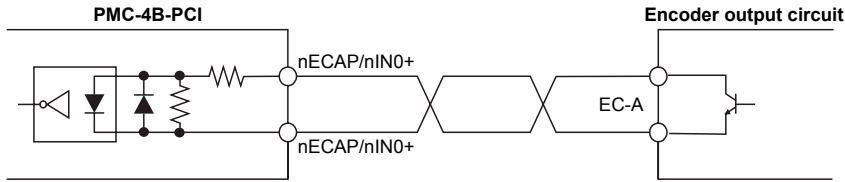

※Encoder A, B, Z phase are same connection.

◎ Example for the connection of encoder input signal and NPN open collector output encode

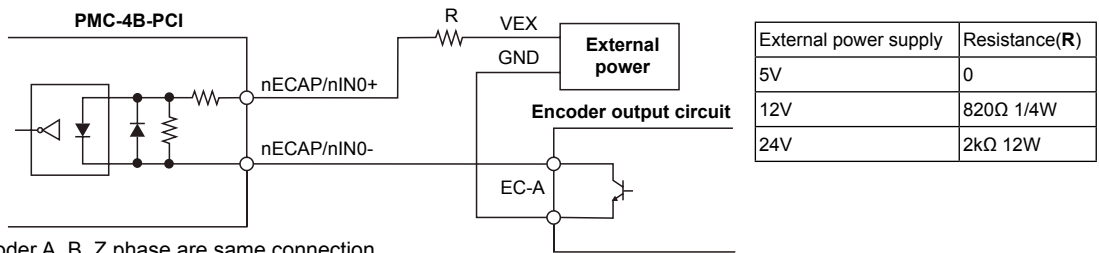

※Encoder A, B, Z phase are same connection.

◎ Connection of input signal (nIN1 to 3, nINPOS, nALRAM, nEXP+/-, EMG)

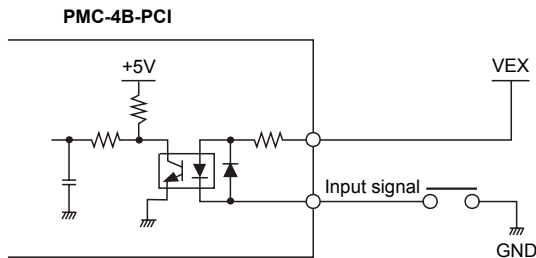

◎ Connection of limit input signal(nLMIT+/-)

The outgoing cable of limit signal can be affected by noise, it can not be removed only with photocoupler, so, the filter circuit is built in and set enough passing time. (FL=2, 3)

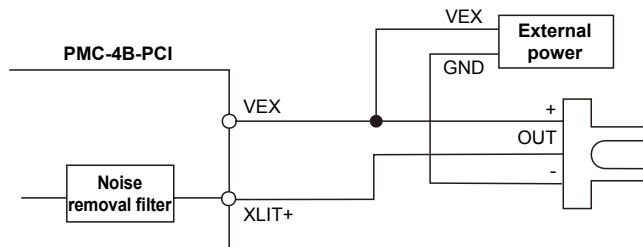

(A)	Photo electric sensor
(B)	Fiber optic sensor
(C)	Door/Area sensor
(D)	Proximity sensor
(E)	Pressure sensor
(F)	Rotary encoder
(G)	Connector/Socket
(H)	Temp. controller
(I)	SSR/ Power controller
(J)	Counter
(K)	Timer
(L)	Panel meter
(M)	Tacho/ Speed/ Pulse meter
(N)	Display unit
(O)	Sensor controller
(P)	Switching mode power supply
(Q)	Stepper motor& Driver&Controller
(R)	Graphic/ Logic panel
(S)	Field network device
(T)	Software
(U)	Other

PMC-4B-PCI

Entire I/O connections

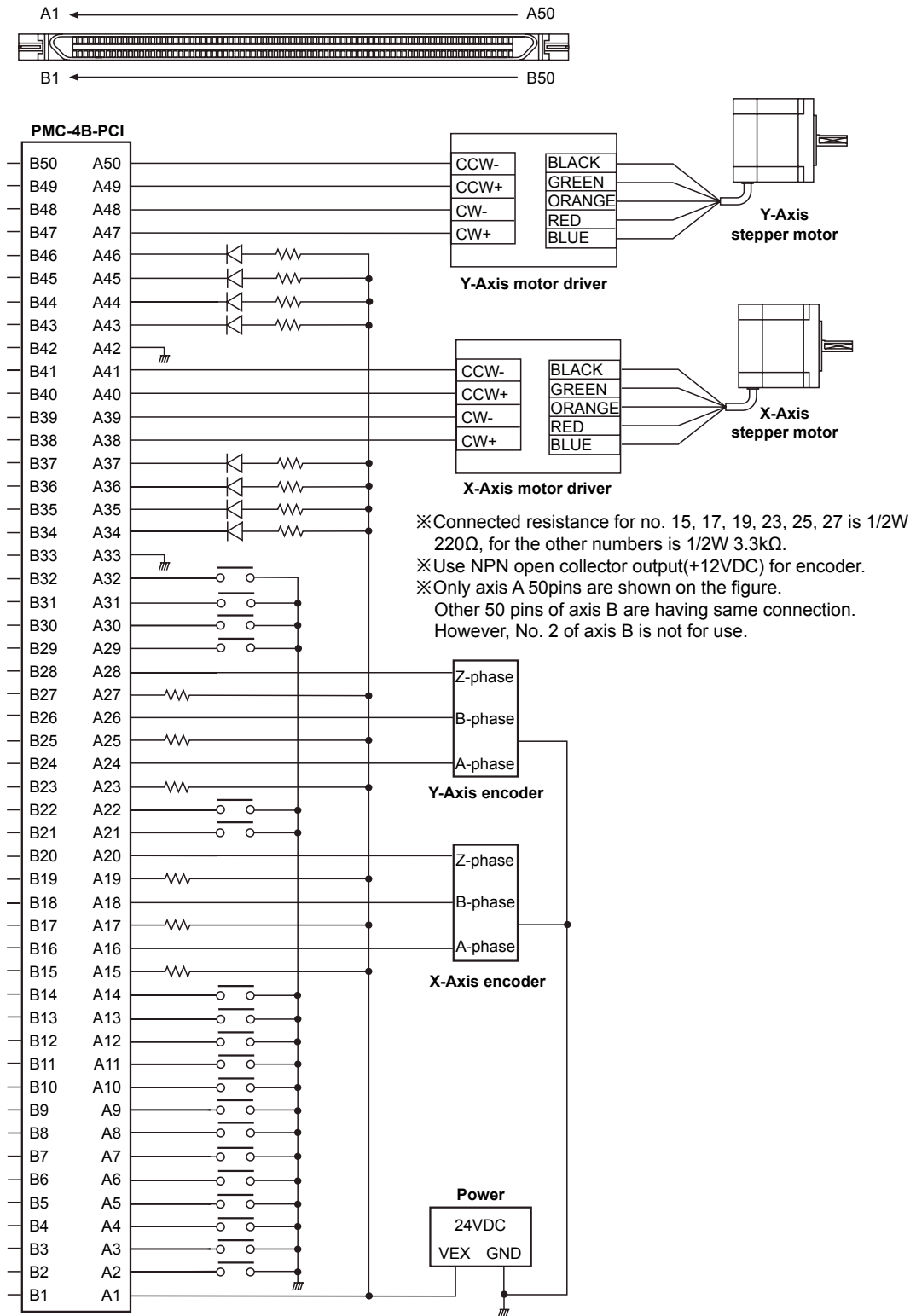

4-Axis Motion Controller

■ I/O specifications

Pin No.	Signal	Description	Pin No.	Signal	Pin description
A1	VEX	12-24VDC	B1	VEX	12-24VDC
A2	EMG	Emergency stop (4-axis stop)	B2	-	-
A3	XLMIT+	X-axis + direction limit	B3	ZLMIT+	Z-axis + direction limit
A4	XLMIT-	X-axis - direction limit	B4	ZLMIT-	Z-axis - direction limit
A5	XIN1	X-axis input signal(home signal)	B5	ZIN1	Z-axis input signal(home signal)
A6	XIN0	X-axis input signal(near home signal)	B6	ZIN0	Z-axis input signal(near home signal)
A7	XIN3	X-axis input signal(Encoder Z phase signal)	B7	ZIN3	Z-axis input signal(Encoder Z phase signal)
A8	YLMIT+	Y-axis + direction limit	B8	ULMIT+	U-axis +direction limit
A9	YLMIT-	Y-axis - direction limit	B9	ULMIT-	U-axis -direction limit
A10	YIN1	Y-axis input signal(home signal)	B10	UIN1	U-axis input signal(home signal)
A11	YIN0	Y-axis input signal(near home signal)	B11	UIN0	U-axis input signal(near home signal)
A12	YIN3	Y-axis input signal(Encoder Z phase signal)	B12	UIN3	U-axis input signal(Encoder Z phase signal)
A13	XINPOS	X-axis inposition input	B13	ZINPOS	Z-axis inposition input
A14	XALRAM	X-axis alarm input	B14	ZALRAM	Z-axis alarm input
A15	XECAP	X-axis Encoder A phase+	B15	ZECAP	Z-axis Encoder A phase+
A16	XECAN	X-axis Encoder A phase-	B16	ZECAN	Z-axis Encoder A phase-
A17	XECBP	X-axis Encoder B phase+	B17	ZECBP	Z-axis Encoder B phase+
A18	XECBN	X-axis Encoder B phase-	B18	ZECBN	Z-axis Encoder B phase-
A19	XECZP	X-axis Encoder Z phase+	B19	ZECZP	Z-axis Encoder Z phase+
A20	XECZN	X-axis Encoder Z phase-	B20	ZECZN	Z-axis Encoder Z phase-
A21	YINPOS	Y-axis inposition input	B21	UINPOS	U-axis inposition input
A22	YALARM	Y-axis alarm input	B22	UALARM	U-axis alarm input
A23	YECAP	Y-axis Encoder A phase+	B23	UECAP	U-axis Encoder A phase+
A24	YECAN	Y-axis Encoder A phase-	B24	UECAN	U-axis Encoder A phase-
A25	YECBP	Y-axis Encoder B phase+	B25	UECBP	U-axis Encoder B phase+
A26	YECBN	Y-axis Encoder B phase-	B26	UECBN	U-axis Encoder B phase-
A27	YECZP	Y-axis Encoder Z phase+	B27	UECZP	U-axis Encoder Z phase+
A28	YECZN	Y-axis Encoder Z phase-	B28	UECZN	U-axis Encoder Z phase-
A29	XEXP+	X-axis manual + drive	B29	ZEXP+	Z-axis manual + drive
A30	XEXP-	X-axis manual - drive	B30	ZEXP-	Z-axis manual - drive
A31	YEXP+	Y-axis manual + drive	B31	UEXP+	U-axis manual + drive
A32	YEXP-	Y-axis manual - drive	B32	UEXP-	U-axis manual - drive
A33	GND	GND	B33	GND	GND
A34	XOUT4/CMPP	X-axis general output	B34	ZOUT4/CMPP	Z-axis general output
A35	XOUT5/CMPP	X-axis general output	B35	ZOUT5/CMPP	Z-axis general output
A36	XOUT6/ASND	X-axis general output	B36	ZOUT6/ASND	Z-axis general output
A37	XOUT7/DSND	X-axis general output	B37	ZOUT7/ DSND	Z-axis general output
A38	XP+P	X-axis +direction +drive signal output	B38	ZP+P	Z-axis +direction +drive signal output
A39	XP+N	X-axis +direction -drive signal output	B39	ZP+N	Z-axis +direction -drive signal output
A40	XP-P	X-axis -direction +drive signal output	B40	ZP-P	Z-axis -direction +drive signal output
A41	XP-N	X-axis -direction -drive signal output	B41	ZP-N	Z-axis -direction -drive signal output
A42	GND	GND	B42	GND	GND
A43	YOUT4/CMPP	Y-axis general output	B43	UOUT4/CMPP	U-axis general output
A44	YOUT5/CMPP	Y-axis general output	B44	UOUT5/CMPP	U-axis general output
A45	YOUT6/ASND	Y-axis general output	B45	UOUT6/ASND	U-axis general output
A46	YOUT7/DSND	Y-axis general output	B46	UOUT7/DSND	U-axis general output
A47	YP+P	Y-axis +direction +drive signal output	B47	UP+P	U-axis +direction +drive signal output
A48	YP+N	Y-axis +direction -drive signal output	B48	UP+N	U-axis +direction -drive signal output
A49	YP-P	Y-axis -direction +drive signal output	B49	UP-P	U-axis -direction +drive signal output
A50	YP-N	Y-axis -direction -drive signal output	B50	UP-N	U-axis -direction -drive signal output

(A)	Photo electric sensor
(B)	Fiber optic sensor
(C)	Door/Area sensor
(D)	Proximity sensor
(E)	Pressure sensor
(F)	Rotary encoder
(G)	Connector/Socket
(H)	Temp. controller
(I)	SSR/ Power controller
(J)	Counter
(K)	Timer
(L)	Panel meter
(M)	Tacho/ Speed/ Pulse meter
(N)	Display unit
(O)	Sensor controller
(P)	Switching mode power supply
(Q)	Stepper motor& Driver&Controller
(R)	Graphic/ Logic panel
(S)	Field network device
(T)	Software
(U)	Other